

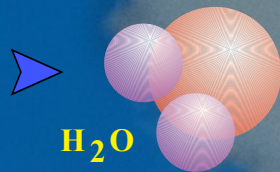

# Thunder Scientific



*About Thunder Scientific Corporation*

*Humidity Generators*

*Calibration Services*

*Thunder Software Center*

*Sales and Ordering Information*

*Support & Service*

**Precision Humidity Generation,  
Calibration and Measurement**

THUNDER SCIENTIFIC CORPORATION  
623 WYOMING BLVD. SE / ALBUQUERQUE, NEW MEXICO 87123-3198  
800-872-7728 / TEL: (505) 265-8701 / FAX: (505) 266-6203  
WWW.THUNDERSCIENTIFIC.COM



Click here to visit Thunder's website.

➔ [www.thunderscientific.com](http://www.thunderscientific.com)

## About Thunder

### Humidity Calibration Equipment and Service...

**Thunder Scientific** is the leading manufacturer of humidity calibration equipment for humidity sensors, hygrothermographs and dewpoint hygrometers which are traceable to the International System of Units (SI) through a national metrology institute (NIST) recognized through a CIPM MRA. Thunder Scientific can calibrate and certify, through the use of fundamentally based two-pressure and two-temperature humidity generator standards, originally established by NIST, virtually any type of humidity sensor or dewpoint measuring equipment over the frostpoint/dewpoint range of -90 °C to +70 °C. Utilizing the speed and reliability of today's computers, the humidity generation process has been automated, increasing overall accuracy and repeatability while reducing uncertainties due to human error or misinterpretation of data. Working toward the goal of increased accuracy, computers now control all aspects of humidity generation, freeing the operator from the burden of continuous and tedious humidity calculations and corrections. The staff at Thunder Scientific has experience with a wide variety of different humidity and dewpoint sensing probe configurations enabling a quick turn around for your instrument. All calibrated instruments will be returned with a detailed Certificate of Calibration, which conforms to ISO/IEC17025:2017 and relevant requirements of ANSI/NCSL Z540-1-1994; Part 1. Thunder now offers NVLAP accredited calibrations, the National Voluntary Laboratory Accreditation Program has assigned a Laboratory Code of 200582-0 to Thunder. [See the NVLAP accreditation page.](#) A complete instrument calibration test procedure can be included upon request. Thunder Scientific's staff is always available for site audit or examination per your specific requirements. Please visit Thunders web-site at [www.thunderscientific.com](http://www.thunderscientific.com) for new equipment news and information.

### Contact Thunder:

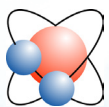

**Thunder Scientific Corporation**  
623 Wyoming Blvd. SE  
Albuquerque, New Mexico 87123-3198

Toll Free: (800) 872-7728  
Tel: (505) 265-8701  
Fax: (505) 266-6203  
Web: [www.thunderscientific.com](http://www.thunderscientific.com)  
E-mail: [sales@thunderscientific.com](mailto:sales@thunderscientific.com)



### Calibration Laboratory

#### Thunder's Calibration Laboratory Now Offers Guard Banding

Thunder Scientific now offers four different levels of Guard Banding as a service for your instruments to keep your equipment at an even a better level of conformity in today's competitive market. Ask our sales representative for a complete description of our Guard Band options.

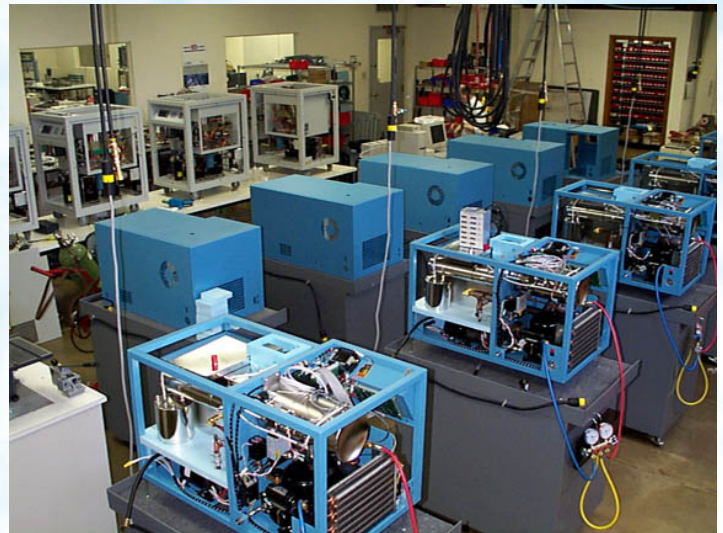

### Manufacturing Plant

Click here to E-mail a Support Representative.

➔ [support@thunderscientific.com](mailto:support@thunderscientific.com)

Click here to E-mail a Sales Representative.

➔ [sales@thunderscientific.com](mailto:sales@thunderscientific.com)

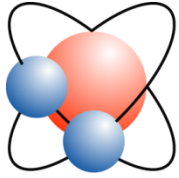

Humidity Generation and Calibration Equipment

**THUNDER SCIENTIFIC**<sup>®</sup>  
**CORPORATION** The Humidity Source



## Thunder's GSA Information

Renewal of Thunder Scientific Corporation's United States General Services Administration (GSA) contract is currently in progress.

Once the new contract has been finalized it will be accessible through this web page, or directly through the General Services Administration (GSA Advantage) website at <https://www.gsaadvantage.gov/>.

For updates on the renewal status, contact us toll free at 1-800-872-7728 or via e-mail at [sales@thunderscientific.com](mailto:sales@thunderscientific.com)

# Thunder Humidity Generators

## **Model ????**

*Replacement for Model 1200 Humidity Generator*



## **Model 2500**

*Mobile Two-Pressure Humidity Generator*



## **New System in 2024**

## **Model 2900**

*Automated Two-Pressure Humidity Generator*



## **Model 3920**

*Two-Pressure Two-Temperature  
Low Humidity Generator*



## **Model 9500**

*Automated Two-Pressure Humidity Generator*



# *Thunder Scientific Corporation*



## *Model 2500*

*Benchtop / Mobile "Two-Pressure"  
Humidity Generator*

# Model 2500

## Benchtop / Mobile "Two-Pressure" Humidity Generator

### FEATURES

- 0.5 %RH Uncertainty <sup>1</sup>
- Traceable to SI <sup>3</sup>
- Self Contained and Mobile
- Automated Control of User Setpoints
- 2500 ControLog<sup>®</sup> Automation Software
- HumiCalc<sup>®</sup> with Uncertainty Software
- Computerized Internal Transducer Calibration
- Low Noise Air Compressor with Air Dryer
- RS-232C Serial Interface

### DESCRIPTION

The **Model 2500** Benchtop Humidity Generator is a self contained system capable of producing atmospheres of known humidities using the fundamental, NIST proven, "two-pressure" principle. This system is capable of continuously supplying accurately known humidity values for instrument calibration, evaluation, and verification, as well as for environmental testing.

Simply apply power and the **2500** will power-up ready to generate. Humidity setpoint values are input by the operator from the front panel keypad and are limited only by the range of the **2500** humidity generator.

Relative humidities are calculated from the measurements of pressure and temperature with the formula:

$$\%RH = \frac{f_s}{f_c} \cdot \frac{e_s}{e_c} \cdot \frac{P_c}{P_s} \cdot 100$$

To generate a known humidity, the computer controls the pressure ratio  $P_c/P_s$  utilizing the enhancement factor ratio  $f_s/f_c$  and the effective degree of saturation  $e_s/e_c$ . Humidity produced is solely dependent on the measurement of pressures and temperatures and does not rely on any other device (such as a dew point hygrometer, psychrometer, or humidity sensor) for the measurement of water vapor content. Precision humidity generation is determined by the accuracy of the pressure measurements and on the accuracy and uniformity of temperature throughout the generating system.



### PRINCIPLE OF OPERATION

The **Model 2500** Benchtop Humidity Generator operates using an on board multifunction CPU in conjunction with other peripheral cards to perform calculation and control functions. The embedded computer control system allows the **2500** to generate known humidity levels unattended, freeing the operating technician from the task of system monitoring and adjustment. A computer and/or printer may be connected via the bidirectional RS-232C interface ports allowing remote setpoint control and continuous acquisition of system data.

Humidity and temperature setpoint values are input by the operator from the front panel keypad while visual indications of system status are displayed in real time on the liquid crystal display.

		SetPnt	Actual	
%RH @ P <sub>c</sub>		20.05	20.05	CHNG SETP
*%RH @ P <sub>c</sub> T <sub>c</sub>		20.00	20.00	
SATUR CHMBR	psi	61.40	61.40	CHNG UNIT
	psi		12.17	
SATUR CHMBR	C	23.00	23.00	EDIT /CRL
			23.05	
FLOW	l/m	20.00	19.88	RUN
08/08/08	11:35:18	E M M M M M I F		

Control Display

All control and measurement parameters critical to the operation of the humidity generator are displayed on this screen. Each parameter in the left most column is identified with a brief title and corresponding units. The generator operates

in a variety of user selectable pressure, temperature, and flow units. Some of these are °C, °F, psi, "Hg, Tor, mbar, kPa, L/min, L/hr, cfm and cfh. Humidity is calculated and displayed in percent relative humidity (%RH). The asterisk in the left most column indicates the active humidity control parameter. The "SetPnt" column lists control setpoints and the "Actual" column lists all of the measured data and calculated parameters of the generator.

**Temperature Control:** The system utilizes a fluid jacketed test chamber for extremely stable temperature control. Temperature setpoint control is attained by controlling the temperature of the circulating fluid medium that jackets the test chamber and associated humidity generation components. Chamber and saturation temperatures are governed by this medium and are digitally controlled by the computer at any value between 0 °C and 70 °C using PID (proportional-integral-derivative) algorithms.

**Pressure And Flow Control:** Pressure control and mass flow control are accomplished through computer actuation of electromechanical valve assemblies. Pressure and flow are measured continuously and controlled using PID algorithms similar to those employed in temperature control.

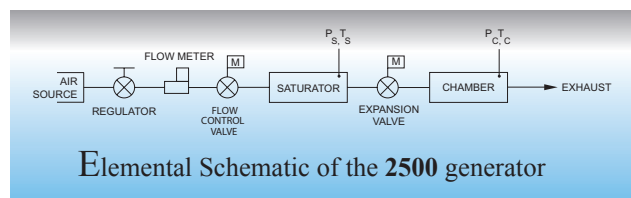

Elemental Schematic of the 2500 generator

**Calibration:** The 2500 humidity generator employs an integral programmatic calibration scheme allowing the temperature and pressure transducers to be calibrated while they are electrically connected to the humidity generator.

	Count	Deg C	
*Satur	Temp 1180	23.41	LOW TEMP
*PrSat	Temp 1165	23.12	MID TEMP
*Chamb	Temp 1173	23.20	HIGH TEMP
Refer	Temp 1257	+1364	EXIT QUIT

LOW	MID	HIGH
0	35	70

Calibration Display

Coefficients for each transducer are calculated by the computer and stored in the system's nonvolatile memory until the next calibration is performed.

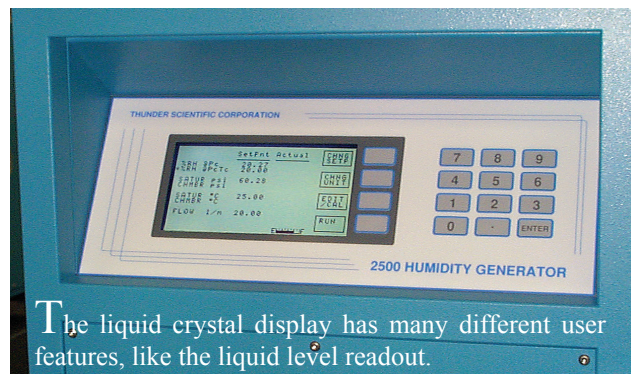

The liquid crystal display has many different user features, like the liquid level readout.

## APPLICATIONS

The fluid jacketed test chamber can accommodate humidity sensors, hygrothermographs, chilled mirror hygrometers, and various material samples for environmental testing.



Virtually any humidity and temperature point may be generated, for any length of time, within the operational limits of the generator. The output of the device under test may then be compared with the generator's printed data for analysis.

**Humidity Sensors And Chart Recorders:** Insert humidity probes through the two inch port in the side of the chamber or place hygrothermographs into the chamber and you can: determine humidity calibration accuracy and characterize humidity sensitivity by subjecting the sensing system to a variety of humidity levels; perform operational checks such as the sensing systems capability to correctly calculate and display other humidity parameters; determine the repeatability, stability, hysteresis, and drift characteristics of various humidity sensing systems.

**Chilled Mirror Hygrometers:** Install the actual chilled mirror head into the chamber or insert a sample tube through the test port and draw a sample through the chilled mirror head and you can: verify mirror temperature measurement accuracy (calibration) when the hygrometer is in thermal equilibrium with its environment; perform operational checks of the heat pump and optical components before and after mirror cleaning and balancing; determine whether the hygrometer is controlling the mirror deposit in the liquid phase or ice phase when operating at dew and frost points below 0°C; determine if the hygrometer is correctly calculating other humidity parameters; determine the hygrometer's repeatability, stability, and drift characteristics.

**Environmental Testing:** The 2500 can serve as a test bed for evaluation and R&D of humidity sensors, humidity sensing systems, and humidity sensitive products, e.g., polymers, composites, film, magnetic medium, blood gas analysis, pharmaceuticals, soil hydrology, consumables, electronics, optics, etc. Depending on the temperature and humidity being generated, the 2500 may operate continuously from hours to months. With continuous generation of a nominal 50 %RH at 21°C, the reservoir will last about two weeks between refills.

# Model 2500 Benchtop / Mobile

## “Two-Pressure” Humidity Generator

### SPECIFICATIONS

Relative Humidity Range:	10 to 95%
Relative Humidity Uncertainty @ P <sub>c</sub> T <sub>c</sub> : <sup>1</sup>	0.5%
Chamber Fluid Temperature Range:	0 to 70 °C
Chamber Fluid Temperature Range: (Optional)	-10 to 70 °C
Chamber Temperature Uniformity: <sup>2</sup>	0.1 °C
Chamber /Saturation Temperature Uncertainty: <sup>1</sup>	0.06 °C
Pre-Saturator/Expansion Valve Temperature Uncertainty: <sup>1</sup>	0.20 °C
Chamber Pressure Range:	Ambient
Chamber Pressure Uncertainty: <sup>1</sup>	0.15% FS
Display Resolution:	0.01
Gas Flow Rate Range:	5 to 20 L/min
Gas Flow Rate Resolution:	0.02 L/min
Gas Flow Rate Uncertainty: <sup>1</sup>	2% FS
Gas Type:	Air or Nitrogen
Gas Pressure Rating (MAWP):	175 psiG
Heating/Cooling Rate:	2.5 Minutes Per °C Average
Chamber Window:	6" x 6" (152 mm x 152 mm)
Physical Dimensions: ...	22" H x 36" W x 23" D (559 mm x 914 mm x 584 mm)
Chamber Dimensions: .	15" H x 15" W x 12" D (381 mm x 381 mm x 305 mm)
Access Port:	Table A

### UTILITIES

Electrical Power:	200/240 V~, 8 A, 60 Hz
(Optional)	200/240 V~, 8 A, 50 Hz
Air Compressor:	100/120 V~, 15 A, 50/60 Hz
(Optional)	200/240 V~, 10 A, 50/60 Hz
Air Supply (External):	Clean Oil Free Instrument Air
	@ 175 psiG & 20 L/min

### ENVIRONMENTAL

Operating Temperature:	15 to 30 °C
Storage Temperature:	0 to 50 °C
Humidity:	5 to 95% RH Non-condensing

**TABLE A**  
Access Port Dimensions

Option	# Ports	Port Diameter	Location
Standard	1	1.9" (48 mm)	Right Side
-TPA	2	1.9" (48 mm)	Right Side
	1	1/4" Swagelok®	Right Side
-LPD	6	1.93" (49 mm)	In Door

Other custom options are available.

<sup>1</sup> Represents an expanded uncertainty using a coverage factor, k=2, at an approximate level of confidence of 95%. Uncertainty for relative humidity is not specified below 0 °C.

<sup>2</sup> When operated at temperatures within 10 °C of room ambient temperature.

<sup>3</sup> Traceable to the International System of Units (SI) through a national metrology institute (NIST) recognized through a CIPM MRA.

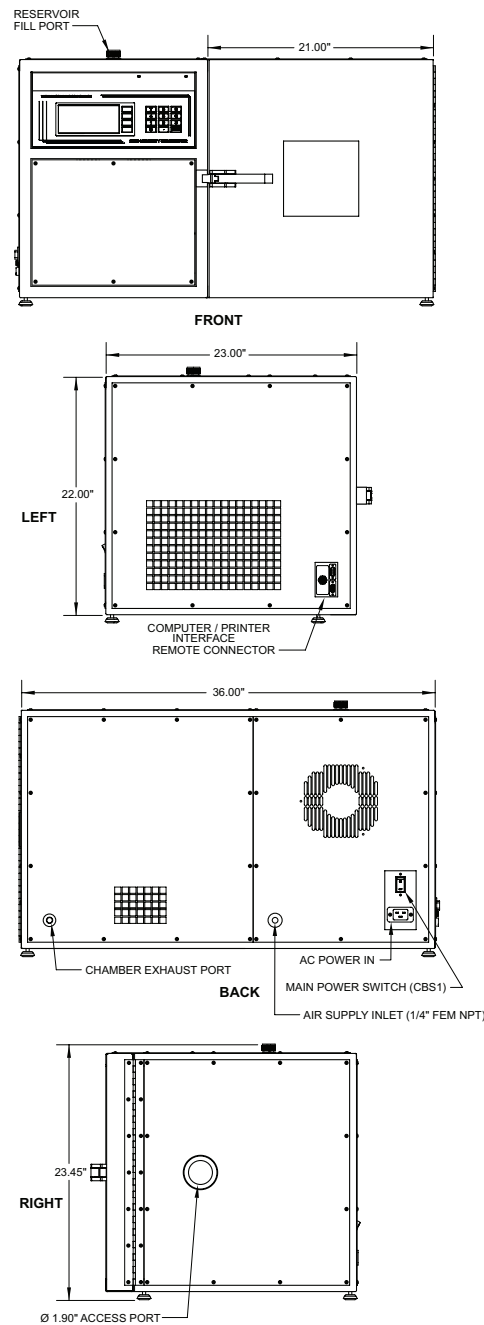

**For More Information or to Place an Order Contact:**



**Thunder Scientific®**

623 Wyoming Blvd. SE ✦ Albuquerque, New Mexico 87123-3198  
Ordering: 800.872.7728 ✦ Tel: 505.265.8701 ✦ FAX: 505.266.6203

[www.thunderscientific.com](http://www.thunderscientific.com)



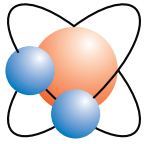

# **THUNDER SCIENTIFIC®**

## **CORPORATION** The Humidity Source

### *Model ACS2520*

*Oil-less Compressed Air System*

A Fully Enclosed Compressed Air Supply  
with Dryer & Sound Muffling Cabinet



#### FEATURES

- Two 175 psiG Oil-Less Air Supplies
- Dry Air To  $<-40^{\circ}\text{C}$  Ambient Pressure Dew Point
- Sound level  $<70$  db
- Vibration Isolated Compressors
- Membrane Air Dryer
- Particulate-Filter
- Pressure Regulator and Air Gauge
- 25' Extension Air Hose
- On/Off Circuit Breaker Switch
- Auto Start Function for the 2500 & 2900 Systems
- 10' Removable AC Power Cord
- **Indoor** Use Only
- Dimensions L 29" x W 18" x H 13"
- Cabinet Weight Approximately 100 Lbs.

Humidity Calibration and  
Measurement Instruments

#### DESCRIPTION

The ACS2520 is used with a Model 2500 or 2900 and fits on the bottom shelf of the mobile cart. This is a fully enclosed compressed air supply with an air dryer and sound muffling cabinet. This system is ideal for in lab use because the sound level is less than 70 decibels. The Model ACS2520 has a hose hold down on top for ease of storage of the extension air hose and has an auto start function when connected with the model 2500 or 2900.

#### SPECIFICATIONS

The ACS2520 has two 3/4 HP oil-less air supplies and can run with a continuous pressure of 165 psi at a maximum ambient air temperature of  $40^{\circ}\text{C}$ . This system can run at a continuous duty of up to 1,500 hours before a minor maintenance service kit is required.

#### VOLTAGE INPUT OPTIONS

You can receive the ACS2520 system in either 115V or 230V at 50/60Hz depending on your needs.

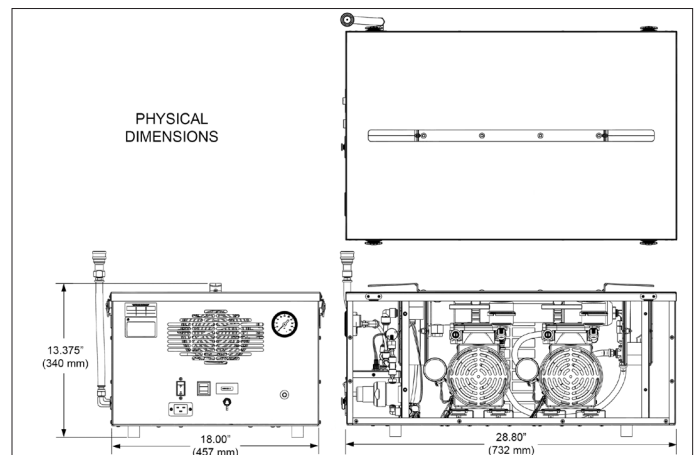

#### ORDERING INFORMATION

When ordering a new air compressor system, part number ACS2520, you will receive an extension air hose, a removable AC power cord and the enclosure with two air compressors. Here are the part numbers for ordering the ACS2520 air compressor system. Use this part number for the 115 volt system, ACS2520-115. If you need to order a high voltage air system, specify this part number, ACS2520-230 for the 230 volt system.

### **THUNDER SCIENTIFIC®**

623 Wyoming Blvd. SE • Albuquerque, New Mexico 87123-3198  
Ordering: 800.872.7728 • Tel: 505.265.8701 • FAX: 505.266.6203

0823-ACS2520

[www.thunderscientific.com](http://www.thunderscientific.com)

# *Thunder Scientific Corporation*



## *Model 2900*

*Automated "Two-Pressure"  
Humidity Generation System*

# *Model 2900*

## *Automated “Two-Pressure” Humidity Generation System*

### FEATURES

- Traceable to SI <sup>1</sup>
- 0.5% of Reading RH Uncertainty <sup>6</sup>
- High Flow Capability of 50 L/min
- Based on the NIST “Two-Pressure” Principle
- ControLog<sup>®</sup> Embedded Automation Software
- Automatically Applies Enhancement Factors
- HumiCalc<sup>®</sup> with Uncertainty Mathematical Engine
- Generate Multipoint Profiles
- Externally Driven Chamber Fan
- 10.1” Multi-point Touch LCD
- Fluid Jacketed Chamber Door
- Window Chamber Door Option (WDA)

### DESCRIPTION

The 2900 Humidity Generation System is a self-contained system capable of producing atmospheres of known humidity using the fundamental “two-pressure” principle. This system is capable of continuously supplying relative humidity, dew point, frost point, parts per million, or other calculated values for instrument calibration and evaluation as well as for precision environmental testing. This system will automatically generate manually entered humidity and temperature set points as well as user created multipoint profiles. All desired humidity’s, temperatures, flow rates, and time intervals may be programmed.

### PRINCIPLE OF OPERATION

The “two-pressure” humidity generation process involves saturating air or nitrogen with water vapor at a known temperature and pressure. The saturated high-pressure air flows from the saturator, through a pressure reducing valve, where the air is isothermally reduced to test pressure at test temperature. Humidity generation is dependent on the measurement of temperature and pressure, not on the amount of water vapor measured in the air. System uncertainty is determined by the temperature and pressure uncertainties, and on the stability and uniformity of the measurements. When setpoint equilibration has been reached, the indication of saturation temperature,



saturation pressure, test temperature, and test pressure, are used in the determination of all hygrometric parameters.

### COMPUTER/CONTROL SYSTEM

The 2900 Humidity Generation System encompasses a high-performance stand-alone Control System that performs all functions required for humidity generation and control. The Control System employs 24 bit I/O modules with integrated signal conditioning to acquire data and uses serial interfaces to transducers and stepper motors to control the operation of generating humidity. The Control System utilizes an embedded operating system in conjunction with specialty software to control and interface with the human to machine interface (HMI) computer running ControLog.

ControLog is an embedded software application that fully automates the operation of the 2900 Humidity Generation System and allows various device connections through a number of different interfaces. ControLog uses Thunder Scientific’s HumiCalc with Uncertainty as its mathematical engine for computing all humidity values and real-time uncertainties. Data from the generator and attached devices is automatically retrieved and stored for viewing in either numerical or graphical format in real time or post process. Data can be transferred off the system via a USB drive for further viewing, post processing and printing using an external Windows PC. The ControLog software also provides the primary interface to the operator

via the multi-point touch LCD which allows the user to select settings like, pressure, temperature, and flow units. Other settings are °C, °F, atm, Pa, hPa, kPa, L/min, L/hr, cfm and cfh. Humidity is calculated and displayed in percent relative humidity (%RH). The Parameter Tab is the primary interface for the user and is divided in two sections, Control and Calculated Humidity. Within each tab there are two different tiles, the Setpoint Tile is for the user to enter the desired setpoints and a Value Tile displays the Actual Value.



**Temperature Control:** The 2900 humidity generation system incorporates a water/glycol jacked test chamber for extremely stable temperature control. The system uses PID (proportional-integral-derivative) algorithms to control the temperature of the chamber fluid as it is pumped around the test chamber and through the saturator at the rate of approximately 14 gallons per minute by a magnetically coupled centrifugal pump.

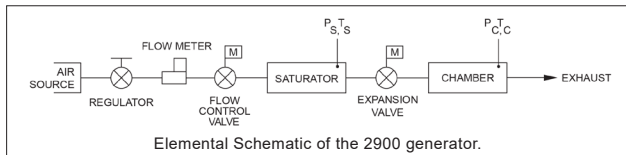

**Pressure and Flow Control:** Pressure control and mass flow control are accomplished through computer actuation of electromechanical valve assemblies. Saturation pressure and mass flow are measured continuously and controlled using PID algorithms similar to those employed in temperature control.

**Calibration:** Proper calibration of the temperature and pressure transducers ultimately determines the accuracy of the generator. The humidity generator employs an integrated software calibration scheme allowing the 2900's probes and transducers to be calibrated while they are electrically connected to the humidity generator. Coefficients for each transducer are calculated by the computer and stored to memory.

## TEST CHAMBER

The 2900 humidity generating system incorporates a test chamber, with internal dimensions of 12" x 12" x 10". Test chamber pressure range is ambient. Access is available

through two 1.875" diameter ports located on the right side. An externally driven, variable speed, chamber fan is incorporated into the rear wall of the test chamber to reduce thermal gradients. The test chamber accommodates various solid-state sensors, sensing systems, chilled mirror hygrometers, as well as material samples for environmental testing. Virtually any humidity and temperature may be generated, for long periods of time, within the operational limits of the generator. The output or recording of the device under test may then be compared with the generator's data for analysis.



## APPLICATIONS

**Humidity Sensors and Chart Recorders:** Insert humidity probes through a test port in the chamber or install the sensing systems into the chamber to: determine humidity calibration accuracy and/or characterize humidity sensitivity by subjecting the humidity sensor to a variety of humidity levels; perform operational checks such as the sensing systems capability to correctly calculate and display other humidity parameters; determine the repeatability, stability, hysteresis, and drift characteristics of various humidity sensing systems.

**Chilled Mirror Hygrometers:** Install the actual chilled mirror head into the chamber or insert a sample tube through the test port and draw a sample through the chilled mirror head to: verify mirror temperature measurement calibration when the hygrometer is in thermal equilibrium with its environment; perform operational checks of the heat pump and optical components before and after mirror cleaning and balancing; determine whether the hygrometer is controlling the mirror deposit in the liquid phase or ice phase when operating at dew and frost points below 0 °C; determine if the hygrometer is correctly calculating other humidity parameters; determine hygrometer's repeatability, stability, and drift characteristics.

**Environmental Testing:** The 2900 can serve as a test bed for evaluation and R&D of humidity sensors, humidity sensing systems, and humidity sensitive products, e.g., polymers, composites, film, magnetic medium, pharmaceuticals, soil hydrology, consumables, electronics, optics, etc.

# Model 2900 Mobile

## Automated Humidity Generation System

### SPECIFICATIONS<sup>1</sup>

Relative Humidity Range: .....	10 to 95 %RH, 10 to 40 L/min
Relative Humidity Range: .....	95 to 98 %RH, 10 to 20 L/min
Frost Point Temperature Range: .....	-33.60 to 0 °C
Dew Point Temperature Range: .....	-36.94 to 70 °C
Chamber Fluid Temperature Range: <sup>2</sup> .....	-10 to 72 °C
Chamber Fluid Temperature Control Stability: <sup>3</sup> .....	0.002 °C
Chamber Temperature Uniformity: <sup>4</sup> .....	< 0.04 °C
Chamber Fluid Temperature Heating Rate: -10 to 72 °C.....	0.5 °C per Minute (avg.)
Chamber Fluid Temperature Cooling Rate: 72 to 0 °C.....	0.5 °C per Minute (avg.)
Chamber Fluid Temperature Cooling Rate: 0 to -10 °C .....	0.2 °C per Minute (avg.)
Temperature Specification: .....	0.027 °C
Gas Type: .....	Air or Nitrogen
Gas Pressure Rating: (MAWP) .....	175 psiG
Gas Flow Rate Range: .....	10 to 50 L/min
Gas Flow Rate Specification:.....	5% of full scale
Saturation Pressure Range: .....	Ambient to 160 psiA
Saturation Pressure Specification:.....	0.02% of full scale
Test Chamber Pressure Range: .....	Ambient
Test Chamber Pressure Specification:.....	0.02% of reading
Display Resolution:.....	0.001
Chamber Window Option: .....	6" x 6" (152 mm x 152 mm)
Test Chamber Dimensions: .....	12" x 12" x 10" (304.8 mm x 304.8 mm x 254 mm)
Physical Dimensions:.....	22" H x 36" W x 23" D (558.8 mm x 432 mm x 584.2 mm)

### UNCERTAINTY<sup>5 & 6</sup>

RH Uncertainty: 10 to 95 %RH, 0 to 70 °C, 10 to 40 L/min.....	0.5% of reading
RH Uncertainty: 95 to 98 %RH, 0 to 70 °C, 10 to 20 L/min.....	0.5% of reading
Dew/Frost Point Uncertainty: < 0 °C, 10 to 40 L/min.....	0.05 °C
Dew Point Uncertainty: 0 to 70 °C, 10 to 40 L/min .....	0.08 °C
Test Chamber Temperature Uncertainty: -10 to 72 °C .....	0.031 °C

### UTILITIES

Electrical Power: .....	200-230/210-240 V~, 10 A, 1 Ø, 50/60 Hz
Gas Supply: .....	175 psiG @ 50 L/min

### ENVIRONMENTAL

Operating Temperature: .....	15 to 30 °C
Storage Temperature: .....	0 to 50 °C
Humidity: .....	5 to 95% RH Non-condensing

- Traceable to the International System of Units (SI) through a national metrology institute (NIST) recognized through a CIPM MRA.
- Only the glycol/water heat transfer fluid circulating around the chamber is controlled to setpoint via the saturation temperature probe. Chamber temperature inside the chamber may vary depending on door configuration, setup, and uniformity. Note: the 2900 can only operate for a finite amount of time at or below 0 °C.
- Temperature Control Stability is defined as the standard deviation over a 10-minute period, as measured by the saturation temperature control sensor after being at point for 60 minutes.
- Chamber Temperature Uniformity is defined as the maximum temperature difference between any two locations at a single point in time. Locations are within one inch of the chamber wall and within 2.5 inches of the chamber door. Using a minimum chamber fan speed of 25% for a temperature range of -10 °C to 72 °C when using fluid jacket door and ±10 °C from ambient when not.
- Chamber pressure at 1 atmosphere. Uncertainty values represent an expanded uncertainty using a coverage factor, k=2, at an approximate level of confidence of 95%.  
Uncertainty is not specified at temperatures below 0 °C or at flow rates below 10 L/min.
- Uncertainty is based on the worst-case value from the 2900 uncertainty analysis.

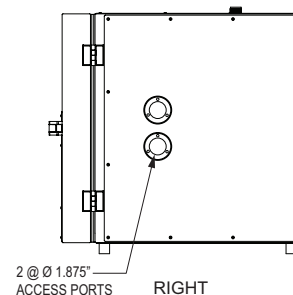
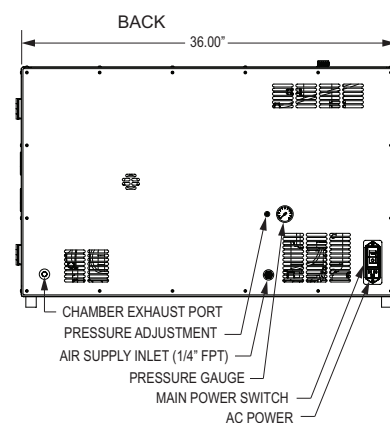
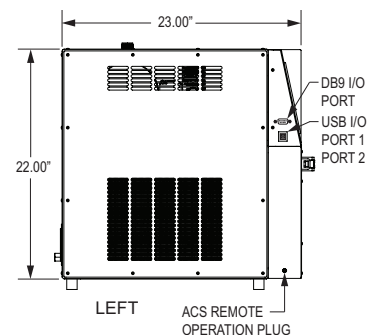
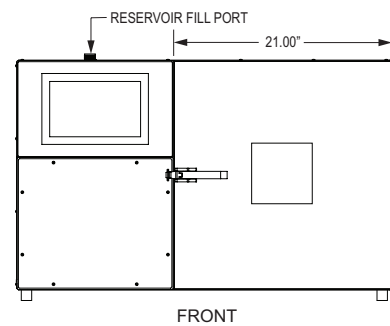

RIGHT  
Dimensions are excluding feet, handle, and other protrusions. Other custom options are available.

**For More Information or to Place an Order Contact:**

**Thunder Scientific®**

623 Wyoming Blvd. SE • Albuquerque, New Mexico 87123-3198  
Ordering: 800.872.7728 • Tel: 505.265.8701 • FAX: 505.266.6203

[www.thunderscientific.com](http://www.thunderscientific.com)

# *Thunder Scientific Corporation*



## *Model 3920*

*“Two-Pressure Two-Temperature”  
Low Humidity Generator*

# Model 3920

## Low Humidity Generation System

### FEATURES

- Traceable to SI<sup>1</sup>
- Based on NIST “Two-Pressure” Principle
- High Flow Capability of 10 L/min
- ControLog<sup>®</sup> Embedded Automation Software
- Generate: Frost Point, Dew Point, PPM, %RH
- HumiCalc<sup>®</sup> Mathematical Engine
- Calculated Real-Time Uncertainty
- Calculated Water Capacity / Usage
- Ability to Operate Using External Computer
- VCR<sup>®</sup> Metal Gasket Face Seal Fittings
- Diaphragm-sealed Control Valves
- 10.1” Multi-Point Touch LCD



### DESCRIPTION

The 3920 Low Humidity Generation System is a self-contained system capable of producing atmospheres of known humidity utilizing the fundamental NIST-proven “two-pressure” “two-temperature” humidity generation principles. This system is capable of continuously supplying frost point, dew point, parts per million, relative humidity and other calculated values for instrument calibration and evaluation as well as for precision environmental testing. This system will automatically generate manually entered humidity setpoints as well as user created multipoint profiles. Visual indications of system status are displayed in real time on the computer monitor.

### PRINCIPLE OF OPERATION

The humidity generation process involves saturating nitrogen or CO<sub>2</sub> free air with water vapor at a known temperature and pressure. The saturated gas is then reduced to test pressure and warmed to test temperature. The measurements of saturation temperature, saturation pressure, test temperature, and test pressure are used in the determination of all hygrometric parameters. System precision is determined by the accuracy and stability of the temperature and pressure measurements. The system does not use or rely on the measurement of water vapor content for calculation or control.

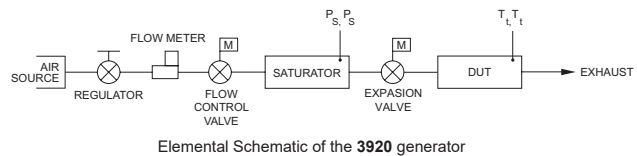

### CONTROL/COMPUTER SYSTEM

The 3920 Low Humidity Generation System encompasses a high-performance stand-alone Control System that performs all functions required for humidity generation and control. The Control System employs 24 bit I/O modules with integrated signal conditioning to acquire analog data, serial interfaces to acquire digital data from the transducers, and digital stepper motor actuated diaphragm valves to control the operation of generating humidity. The Control System utilizes an embedded operating system in conjunction with specialty software to control and interface with the human to machine interface (HMI) computer that runs ControLog<sup>®</sup>.

ControLog is an embedded software application that fully automates the operation of the 3920 Low Humidity Generation System and allows various device connections through a number of different interfaces. ControLog uses Thunder Scientific’s HumiCalc with Uncertainty<sup>®</sup> as its mathematical engine for computing all humidity values and real-time uncertainties. Data from the generator and attached devices is automatically retrieved and stored for viewing in either numerical or graphical format in real time or post process.

Data can be transferred off the system via a USB drive for further viewing, post processing and printing using an external Windows PC. The ControLog software also provides the primary interface to the operator via the multi-point touch display. The main panel has easy access to the keyboard allowing the user to input data directly without connecting an external PC.

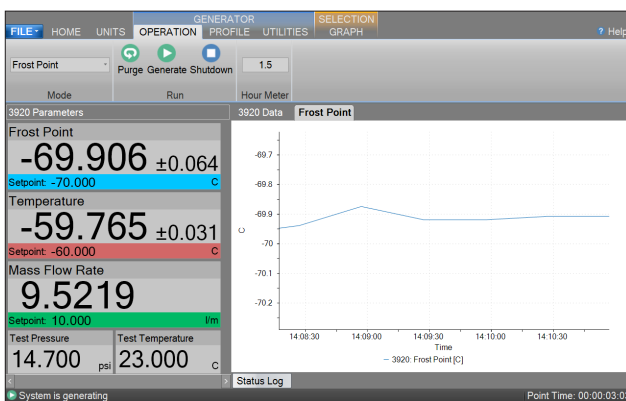
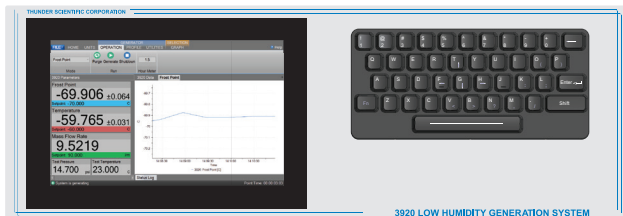

The Water Capacity dialog allows the user to view the current estimated water remaining in the generator and allows the user to perform clear cycles after filling.

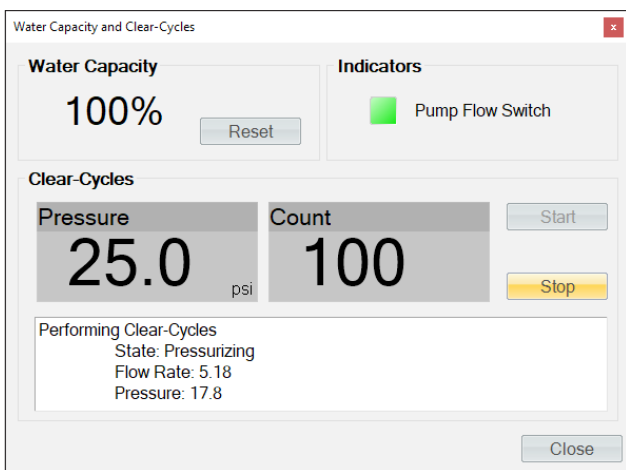

An external Windows PC can also be connected via an RS-232 connection to run a desktop version of ControLog. The desktop version has the same functionality as the embedded version but runs on a stand-alone Windows PC (not included). This allows the user to operate the software with larger displays or on specific computer networks to aid in file saving and transfer.

During desktop operation the embedded version locks out user setpoint changes but still allows data viewing and graphing.

**Temperature Control:** Temperature setpoint control is attained by controlling the temperature of a circulating fluid medium that jackets the saturator of the generator. The saturation temperature is governed by the temperature of this medium, which is digitally controlled by the computer at any value between  $-80^{\circ}\text{C}$  and  $12^{\circ}\text{C}$  through the use of PID (proportional-integral-derivative) algorithms.

**Pressure and Flow Control:** Saturation pressure control and mass flow control is accomplished through computer actuation of electromechanical diaphragm sealed valve assemblies. Saturation pressure and mass flow are measured continuously and controlled using PID algorithms similar to those employed in temperature control. All fittings in the humidity generating path are VCR<sup>®</sup> Metal Gasket Face Seals and all valves in the humidity generating path are diaphragm-sealed for reduced water vapor permeation. All interconnect tubing is electro-polished 316 stainless steel.

**Calibration:** Proper calibration of the temperature and pressure transducers ultimately determines the uncertainty of the generator. This system employs an integral programmatic calibration scheme allowing the transducers to be calibrated while they are electrically connected to the humidity generator.

## APPLICATIONS

**Chilled Mirror Hygrometers:** Connecting the generator output to a chilled mirror hygrometer allows the user to verify the mirror temperature measurement accuracy; perform operational checks on the hygrometer components; determine whether the hygrometer is controlling the mirror in the liquid phase or ice phase when operating below  $0^{\circ}\text{C}$ ; determine if the hygrometer is correctly calculating other humidity parameters; determine hygrometer repeatability, stability, and drift characteristics.

**Humidity Sensors and Electrolytic Hygrometers:** Connecting the generator output to special fixtures, hygrometer sampling systems, or individual sensors allows the user to calibrate and/or characterize humidity sensitivity; perform operational checks such as the sensing systems capability to correctly calculate and display other humidity parameters; determine repeatability, stability, hysteresis and/or drift characteristics of various humidity sensing systems.

**Environmental Testing:** The 3920 can serve as a test bed for evaluation and R&D of humidity sensors, humidity sensing systems, and humidity sensitive products, e.g., polymers, composites, film, magnetic medium, pharmaceuticals, soil hydrology, consumables, electronics, optics, etc.



# Model 3920

## Low Humidity Generation System

### SPECIFICATIONS<sup>2</sup>

Frost Point Temperature Range:	-95 to 0.01 °C
Dew Point Temperature Range:	-50 to 10 °C
Parts Per Million Range:	0.04 to 12300 PPMv
Relative Humidity Range:	0.00003% to ~50%
Saturation Temperature Range: <sup>3</sup>	-80 to 12 °C
Saturation Temperature Control Stability: <sup>4</sup>	0.008 °C
Saturation Temperature Cooling Rate: from 12 to -80 °C	0.33 °C per Minute (average)
Saturation Temperature Heating Rate: from -80 to 12 °C	0.33 °C per Minute (average)
Test Temperature Range (measured):	0 to 50 °C
Saturation Pressure Range:	~Ambient to 250 psiA
Saturation Pressure Specification:	0.02% of full scale
Test Pressure Range (measured):	Ambient to 50 psiA
Test Pressure Specification:	0.02% of full scale
Gas Type:	Gaseous Nitrogen or CO <sub>2</sub> free Air
Supply Pressure Range:	80 to 300 psiG
Supply Pressure Specification:	±1.25 psiG
Gas Flow Rate Range:	0.5 to 10 SLPM
Gas Flow Rate Specification:	2% of full scale
Display Resolution:	0.001
Refrigeration:	1/3 HP R-134A & 1/3 HP R-23 in cascade
Heating:	Stainless Steel Immersion
Test Port & Gas Inlet:	1/4 Inch Swagelok VCR®
Physical Dimensions:	38" H x 23" W x 35" D (965.2 mm x 584.2 mm x 889 mm)

### UNCERTAINTY<sup>2,5,6</sup>

Dew Point Uncertainty: -50 °C to 10 °C	0.01%  R  + 0.07 °C
Frost Point Uncertainty: ≥-90 °C	0.05%  R  + 0.07 °C
Frost Point Uncertainty: < -90 °C	1.7%  R  - 1.45 °C
Test Temperature Uncertainty: 0 to 50 °C	0.031 °C

### UTILITIES

Electrical Power:	220/230 V~, 10 A, 1 Ø, 50/60 Hz
Gas Supply:	80 psiG to 300 psiG @ 10 L/min
Floor Space:	9 ft <sup>2</sup> (0.84 m <sup>2</sup> )

### ENVIRONMENTAL

Operating Temperature:	15 to 30 °C
Storage Temperature:	0 to 50 °C
Humidity:	5 to 95% RH Non-condensing

<sup>1</sup> Traceable to the International System of Units (SI) through a national metrology institute (NIST) recognized through a CIPM MRA.

<sup>2</sup> Test pressure at 1 atmosphere.

<sup>3</sup> Using anhydrous methanol as the temperature heat transfer fluid from -80 to 12 °C.

<sup>4</sup> Temperature Control Stability is defined as the standard deviation over a 10-minute period, as measured by the saturation temperature control sensor after being at point for 60 minutes.

<sup>5</sup> Uncertainty values represent an expanded uncertainty using a coverage factor, k=2, at an approximate level of confidence of 95%.

<sup>6</sup> Uncertainty is based on the worst-case value from the 3920 uncertainty analysis.

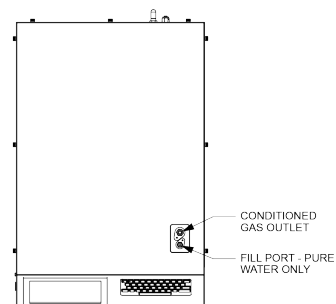

TOP VIEW

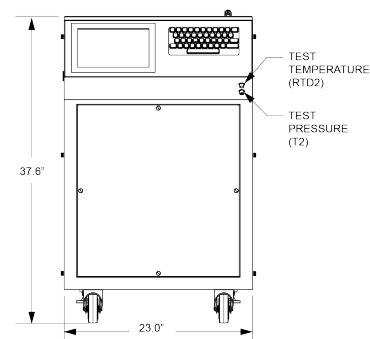

FRONT VIEW

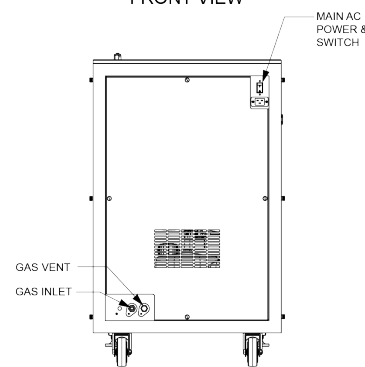

REAR VIEW

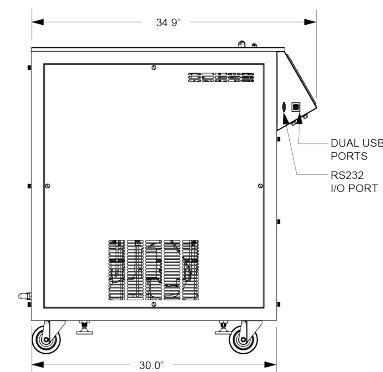

LEFT VIEW

**For More Information or to Place an Order Contact:**

**Thunder Scientific®**

623 Wyoming Blvd. SE • Albuquerque, New Mexico 87123-3198  
 Ordering: 800.872.7728 • Tel: 505.265.8701 • FAX: 505.266.6203

[www.thunderscientific.com](http://www.thunderscientific.com)

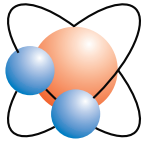

# **THUNDER SCIENTIFIC®**

## **CORPORATION** The Humidity Source

### *Model ACS3920*

*CO<sub>2</sub> Free Dry Air Compressor System*

A Fully Enclosed Compressed Air Supply  
with Dryers & Sound Muffling Cabinet



#### **FEATURES**

- 100 psiG Oil-Less Air Supply
- Dry Air To -70 °C Frost Point @ Ambient Pressure
- Sound level <70 db
- Vibration Isolated Compressor
- Membrane Air Dryer
- CO<sub>2</sub> Adsorber/Air Dryer
- Pressure Regulator/Air Gauges: Hour Meter
- Remote Start Function
- 5' Air-Out Supply Tube with Fittings
- 8' Removable AC Power Cord
- Indoor Use Only
- Dimensions L 28.95" x W 18.10" x H 14.0"
- Cabinet Weight Approximately 75 Lbs.
- Rolling/Locking Casters (Optional)

Humidity Calibration and  
Measurement Instruments

#### **DESCRIPTION**

The ACS3920 Air Compressor System with integral CO<sub>2</sub> Adsorber/Air Dryer provides a clean, dry, continuous duty gas supply for the Thunder Scientific Low Humidity Generators. The ACS3920 Air Compressor System consists of a vibration isolated 3/4 HP oil-less compressor, membrane air dryer, CO<sub>2</sub> Adsorber/Air Dryer, and adjustment regulators, all incorporated into a sound muffling enclosure. The ACS3920 is ideal for laboratory use due to its small size, 100 psiG pressure output at 10 L/min, -70 °C frost point capability at ambient pressure, and a low sound level of less than 70 decibels.

This system will operate up to 1,500 hours before a minor maintenance service kit is required. Optional Rolling/Locking casters are available.

#### **VOLTAGE INPUT OPTIONS**

You can receive the ACS3920 system in either 115V or 230V at 50/60Hz depending on your needs.

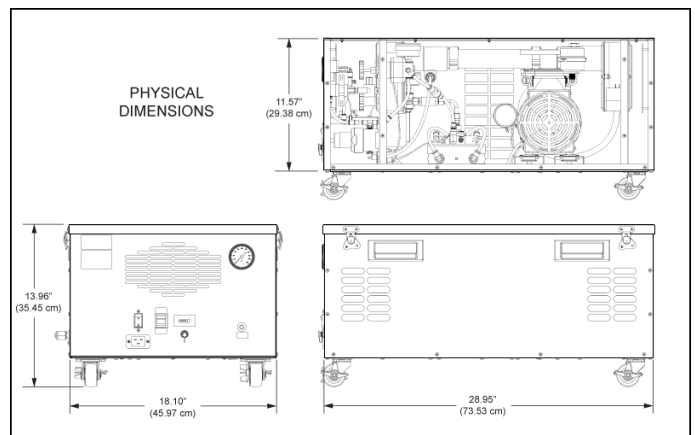

#### **ORDERING INFORMATION**

When ordering a new air compressor system, model number ACS3920, you will receive a 5 foot extension air supply tube with connectors, a removable AC power cord and the enclosure with air compressor and dryers. The part numbers for ordering the ACS3920 are ACS3920-115 for 115VAC 50/60Hz or ACS3920-230 for 230VAC 50/60Hz.

## **THUNDER SCIENTIFIC®**

623 Wyoming Blvd. SE • Albuquerque, New Mexico 87123-3198  
Ordering: 800.872.7728 • Tel: 505.265.8701 • FAX: 505.266.6203

0323-ACS3920

[www.thunderscientific.com](http://www.thunderscientific.com)

# *Thunder Scientific Corporation*



## *Model 9500*

*Automated "Two-Pressure"  
Humidity Generation System*

# Model 9500

## Automated Humidity Generation System

### FEATURES

- Traceable to SI <sup>1</sup>
- 0.17% \* R + 0.016 RH Uncertainty <sup>4, 5</sup>
- High Flow Capability
- Based on NIST Proven “Two-Pressure” Principle
- Generate: RH, DP, FP, PPM, Multipoint Profiles
- Computes System Uncertainties in Real Time
- Automatically Applies Enhancement Factors
- ControLog<sup>®</sup> Embedded Automation Software

### DESCRIPTION

The **9500** Humidity Generation System is capable of producing known humidity values using the fundamental, NIST proven, “two-pressure” principle. The **9500** is capable of continuously supplying relative humidity, dew point, frost point, parts per million, or other calculated values for instrument calibration and evaluation as well as precision environmental testing. This system will automatically generate manually entered humidity and temperature set points as well as user created multipoint profiles. All desired humidity’s, temperatures, test pressures, flow rates, and time intervals may be programmed. Visual indications of system status are displayed in real time on the computer monitor.

### PRINCIPLE OF OPERATION

The “two-pressure” humidity generation process involves saturating air or nitrogen with water vapor at a known temperature and pressure. The saturated high pressure air flows from the saturator, through a pressure reducing valve, where the air is isothermally reduced to test pressure at test temperature. Humidity generation is dependent on the measurement of temperature and pressure, not on the amount of water vapor measured in the air. System uncertainty is determined by the temperature and pressure uncertainties, *and* on the stability and uniformity of the measurements. When setpoint equilibration has been reached, the indication of saturation temperature, saturation pressure, test temperature, and test pressure, are used in the determination of all hygrometric parameters.



### COMPUTER/CONTROL SYSTEM

The **Model 9500** Humidity Generation System encompasses a high-performance stand-alone Control System that performs all functions required for humidity generation and control. The Control System employs 24 bit I/O modules with integrated signal conditioning to acquire data and uses serial interfaces to transducers and stepper motors to control the operation of generating humidity. The Control System utilizes an embedded operating system in conjunction with specialty software to control and interface with the human to machine interface (HMI) computer running ControLog.

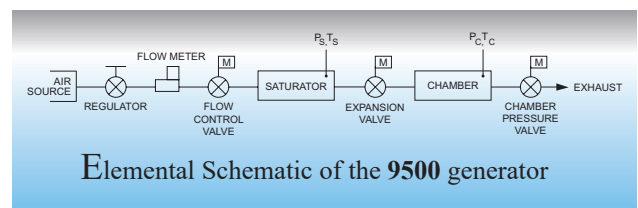

Elemental Schematic of the 9500 generator

ControLog is an embedded software application that fully automates the operation of the **9500** Humidity Generation System and allows various device connections through a number of different interfaces. Data from the generator and attached devices is automatically retrieved and stored for viewing in either numerical or graphical format in real time or post process. Data can be transferred off the system via a USB drive for further viewing and post processing using an external Windows PC. The ControLog software also provides the primary interface to the operator via the multi-point touch display and keyboard.

### Key features of the ControLog software are:

- Data stored to individual data tabs in a worksheet type view.
- Graphing tabs to create a visual picture of the stored data.
- Auto Profiling to automate the generator operation.
- Device connections that work with most devices to allow data communication with the devices under test.

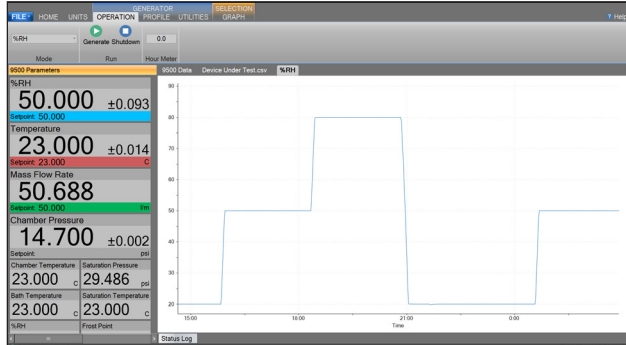

ControLog Computer Screen

**Temperature Controlled Bath:** The 9500 humidity generating system incorporates an extremely stable temperature bath. Bath temperature is digitally controlled by the computer to any value between 0 °C and 72 °C using PID (proportional-integral-derivative) algorithms. The test chamber, saturators, heat exchangers, and connecting tubing are immersed in approximately 20 gallons of distilled water that is circulated at the rate of 50 gallons per minute by a magnetically coupled centrifugal pump. Fast fluid circulation provides the temperature conditioning of these components resulting in excellent bath stability and uniformity.

**Pressure and Flow Control:** Pressure control and mass flow control are accomplished through computer actuation of electromechanical valve assemblies. Saturation pressure, chamber pressure, and mass flow are measured continuously and controlled using PID algorithms similar to those employed in temperature control.

**Calibration:** Proper calibration of the temperature and pressure transducers ultimately determines the accuracy of the generator. The 9500 employs an integrated software calibration scheme allowing the 9500's transducers to be calibrated while they are electrically connected to the humidity generator. Coefficients for each transducer are calculated by the computer and stored to memory.

## TEST CHAMBER

The 9500 humidity generating system incorporates a completely immersed test chamber, with internal dimensions of 12" x 12" x 12". Test chamber pressure range is ambient to 20 PSIA. The main chamber cover is removable utilizing quick release hold downs. Removal of the chamber cover allows a full 12 inch by 12 inch access to the test space. Access is also available through two 3.65" diameter ports in the chamber cover or two 1.125" inside diameter port cover

adapters. The test chamber can accommodate various solid state sensors, chilled mirror hygrometers, as well as material samples for environmental testing. Virtually any humidity and temperature may be generated, for long periods of time, within the operational limits of the generator. The output or recording of the device under test may then be compared with the generator's data for analysis.



Four Port Option Shown

## APPLICATIONS FOR USE

**Chilled Mirror Hygrometers:** Install the actual chilled mirror head into the chamber or insert a sample tube through a test port and draw a sample through the chilled mirror head to: verify mirror temperature measurement accuracy (calibration) when the hygrometer is in thermal equilibrium with its environment; perform operational checks of the heat-pump and optical components before and after mirror cleaning and balancing; determine whether the hygrometer is controlling the mirror deposit in the liquid phase or ice phase when operating at dew and frost points below 0°C; determine if the hygrometer is correctly calculating other humidity parameters; determine the hygrometer's repeatability, stability, and drift characteristics.

**Humidity Sensors and Chart Recorders:** Insert your humidity probe through a test port in the chamber or install the humidity sensing system directly into the chamber to: determine humidity calibration accuracy and/or characterize humidity sensitivity by subjecting the humidity sensor to a variety of humidity levels; perform operational checks such as the sensing systems capability to correctly calculate and display other humidity parameters; determine the repeatability, stability, hysteresis, and drift characteristics of various humidity sensing systems.

**Environmental Testing:** The 9500 can serve as a test bed for evaluation and R&D of humidity sensors, humidity sensing systems, and humidity sensitive products, e.g., polymers, composites, film, magnetic medium, pharmaceuticals, soil hydrology, consumables, electronics, optics, etc.

# Model 9500

## Automated Humidity Generation System

### SPECIFICATIONS

Relative Humidity Range: (Test Chamber @ 14.7 psiA)	5 to 98 %RH
Dew Point Temperature Range: (Test Chamber @ 14.7 psiA)	-35 to 70 °C
Frost Point Temperature Range: (Test Chamber @ 14.7 psiA)	-32 to 0 °C
Bath Temperature Range: <sup>2</sup>	0 to 72 °C
Bath Temperature Control Stability: <sup>3</sup>	0.002 °C
Bath Temperature Heating Rate: from 0 to 72 °C	0.5 °C per Minute (average)
Bath Temperature Cooling Rate: from 72 to 0 °C	0.5 °C per Minute (average)
Chamber Temperature Uniformity: <sup>4</sup>	0.008 °C
Gas Type:	Air or Nitrogen
Gas Pressure Rating: (MAWP)	350 psiG
Gas Flow Rate Range:	10 to 100 L/min
Gas Flow Rate Specification:	±2% of full scale
Supply Pressure Specification:	±1.25 psiG
Saturation Pressure - Low Range:	Ambient to 45 psiA
Saturation Pressure - High Range:	>45 to 325 psiA
Test Chamber Pressure Range:	Ambient to 15 psiA
Display Resolution:	0.001
Test Chamber Dimensions:	12" x 12" x 12" (304.8 mm x 304.8 mm x 304.8 mm)
Physical Dimensions:	38.3" H x 60" W x 36" D (971.5 mm x 1524.0 mm x 914.4 mm)

### UNCERTAINTY <sup>5, 6, 7, 8</sup>

Relative Humidity: 5 to 98 %RH, 10 to 100 L/min	0.17% * R + 0.016
Example 1: If the %RH reading is 50 %RH. The uncertainty would then be:	0.17% * 50 + 0.016 = 0.101
Example 2: If the %RH reading is 10 %RH. The uncertainty would then be:	0.17% * 10 + 0.016 = 0.033
Dew Point: -27 °C to +70 °C Dew Point (Ps ≤ 140 psiA), 10 to 100 L/min	0.03 °C
-35 °C to < -27 °C Dew Point (Ps > 140 psiA), 10 to 100 L/min	0.05 °C
Frost Point: -22 to 0.01 °C Frost Point (Ps ≤ 100 psiA), 10 to 100 L/min	0.03 °C
-32 to < -22 °C Frost Point, (Ps > 100 psiA), 10 to 100 L/min	0.05 °C
Temperature: 0 to 72 °C <sup>8</sup>	0.015 °C
Test Chamber Pressure: Ambient to 15 psiA	0.0021 psiA
Low-Range Saturation Pressure: Ambient to 45 psiA	0.0042 psiA
High-Range Saturation Pressure: >45 to 325 psiA	0.03 psiA

### UTILITIES

Electrical Power:	208-240 V~, 20 A, 3 Ø, 50/60 Hz, 4 Wire
Gas Supply:	350 psiG @ 100 L/min
Cooling Water:	2 gpm (8 L/min) Maximum @ 21 °C

### ENVIRONMENTAL

Operating Temperature:	15 to 30 °C
Storage Temperature:	0 to 50 °C
Humidity:	5 to 95% RH Non-condensing

- Traceable to the International System of Units (SI) through a national metrology institute (NIST) recognized through a CIPM MRA.
- Using glycol/water as the temperature bath heat transfer fluid from 0 to 5 °C and water as the temperature bath heat transfer fluid from 5 °C to 72 °C.
- Temperature Control Stability is defined as the maximum deviation from a best fit line, as measured by the bath temperature control sensor. If data is logged digitally, the best fit line will be defined as the average value over the 10 minute period. All measurements made with an insulated cover in place over bath.
- Chamber Temperature Uniformity is defined as the maximum temperature difference between any two locations over the temperature range of 0 °C to 72 °C when using a thermal insulator over the bath, such as hallow bath balls. Locations are defined at the center of the chamber lid access ports, approximately 5" into the chamber.
- Refer to "Model\_9500\_Uncertainty\_Analysis\_Rev3.2.pdf" for more information.
- Uncertainty is not specified at flow rates below 10 slpm and above 100 slpm.
- Uncertainty values represent an expanded uncertainty using a coverage factor, k=2, at an approximate level of confidence of 95%.
- Includes saturation temperature, chamber temperature, bath temperature, pre-saturator temperature, and exp-valve temperature.

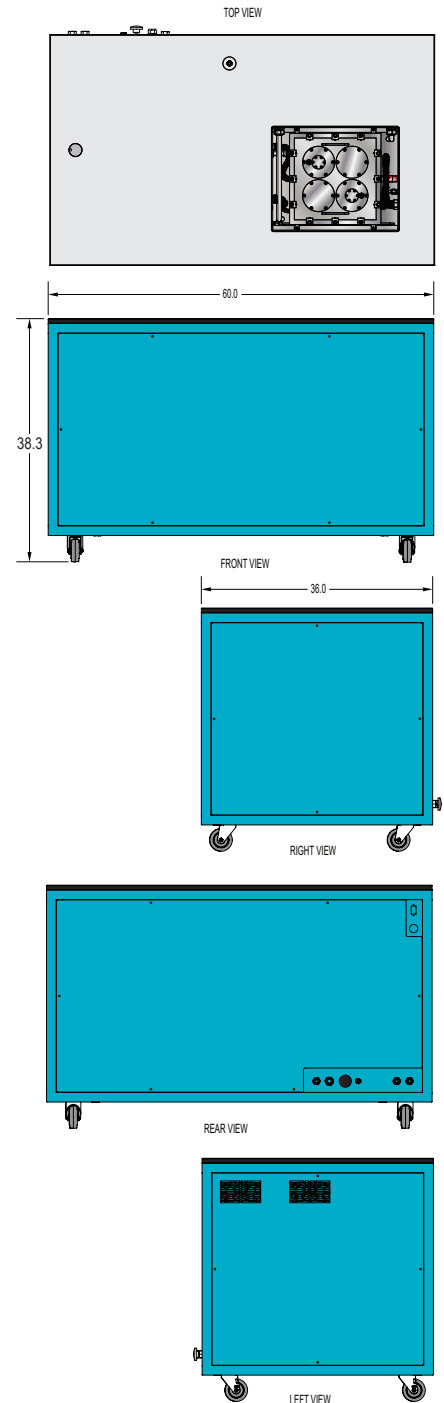

**For More Information or to Place an Order Contact:**

**Thunder Scientific®**

623 Wyoming Blvd. SE • Albuquerque, New Mexico 87123-3198  
Ordering: 800.872.7728 • Tel: 505.265.8701 • FAX: 505.266.6203

[www.thunderscientific.com](http://www.thunderscientific.com)

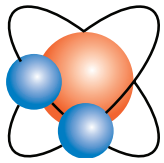

## Accredited Humidity Calibration Services Traceable to The International System Of Units (SI)

### Traceability:

Traceable to the International System of Units (SI) through the National Institute of Standards and Technology (NIST) recognized through a CIPM MRA, Humidity – Dewpoint – PPM, temperature and pressure.

Calibrations are compliant with: ISO/IEC 17025:2017 and ANSI/NCSL Z540-1-1994; Part 1.

Thunder Scientific maintains calibration systems capable of producing known humidity values using the combined fundamental “two-pressure” and “two-temperature” principle. These systems are capable of continuously supplying accurately known humidity, temperature, and pressure values for instrument calibration and special tests.

### Calibration Laboratory Capabilities

Humidity Parameter	Range	Uncertainty
Relative Humidity	> 0% to 98%	(0.17% * R) + 0.016 %RH
Dew / Frost Point	-90 to < -80 °C	0.50 °C
	-80 to < -70 °C	0.20 °C
	-70 to < -35 °C	0.10 °C
	-35 to < -27 °C	0.05 °C
	-27 to 70 °C	0.03 °C
Volume ratio, V (ppm)	0.1 to 3.0 ppm	4.0% of value
	3.0 to 200 ppm	2.0% of value
	200 to 400000 ppm	0.1% of value

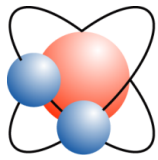

Humidity Generation and Calibration Equipment

**THUNDER SCIENTIFIC®**  
**CORPORATION** The Humidity Source



Click here to go to our  
[Certificate of Accreditation](#)  
(PDF: 379 KB).



**Cert >**



**Scope >**

Click here to go to our  
[Scope of Accreditation](#)  
(PDF: 227 KB).

Since 2003, Thunder Scientific Corporation's Calibration Laboratory has maintained its accreditation from the National Voluntary Laboratory Accreditation Program (NVLAP Laboratory Code 200582-0), administered by the National Institute of Standards and Technology/US Department of Commerce. Please follow the link below to view/download our current NVLAP Certificate/Scope of Accreditation:

<https://www-s.nist.gov/niws/index.cfm?event=directory.search>

### Thunder Scientific offers NVLAP Accreditation for Field Calibrations

Thunder Scientific has added to its scope of accreditation, field calibration of all series 1200, 2500 and 2900 humidity generators. Holding true to Thunder Scientific's commitment to quality, all field calibrations are compliant to ISO/IEC 17025:2017 and ANSI/NCCL Z540-1-1994, Part 1 requirements.

Thunder's Calibration Laboratory field support staff will travel to your location with traceable standards for dew-point inter-comparison, pressure calibration and temperature calibration of your Model 1200, 2500 and 2900 generators. Our field support staff will inspect and conduct all required maintenance on your humidity generator. Calibration reports include the NVLAP logo and laboratory code, "As Found" data, "As Left" data, and a concise statement of the method used.

Thunder's accredited humidity uncertainties are the lowest commercially available. Our turn-around times are excellent, and prices are very competitive.

NVLAP accreditation criteria are established in accordance with the U.S. Code of Federal Regulations (CFR, Title 15, Part 285), NVLAP Procedures and General Requirements, and encompass the requirements of ISO/IEC 17025. Accreditation is granted following successful completion of a process which includes submission of an application and payment of fees by the laboratory, an on-site assessment, resolution of any nonconformities identified during the on-site assessment, participation in proficiency testing, and technical evaluation. The accreditation is formalized through issuance of a Certificate of Accreditation and Scope of Accreditation and publicized by announcement in various government and private media.

NVLAP provides an unbiased third-party evaluation and recognition of performance, as well as expert technical guidance to upgrade laboratory performance. NVLAP accreditation signifies that a laboratory has demonstrated that it operates in accordance with NVLAP management and technical requirements pertaining to quality systems; personnel; accommodation and environment; test and calibration methods; equipment; measurement traceability; sampling; handling of test and calibration items; and test and calibration reports.

More information about the NVLAP program can be found at <https://www.nist.gov/accreditation/>.

Please contact: Thunder Scientific Corporation sales department if you have questions or would like to arrange for a NVLAP accredited calibration. You can reach us toll free at 800-872-7728 or via e-mail at [sales@thunderscientific.com](mailto:sales@thunderscientific.com)

**Disclaimer:** Use of the NVLAP symbol does not imply product certification, approval, or endorsement by NVLAP, NIST, or any agency of the U.S. Government.



# Thunder Software

## 2500 ControLog® Automation and Control Software

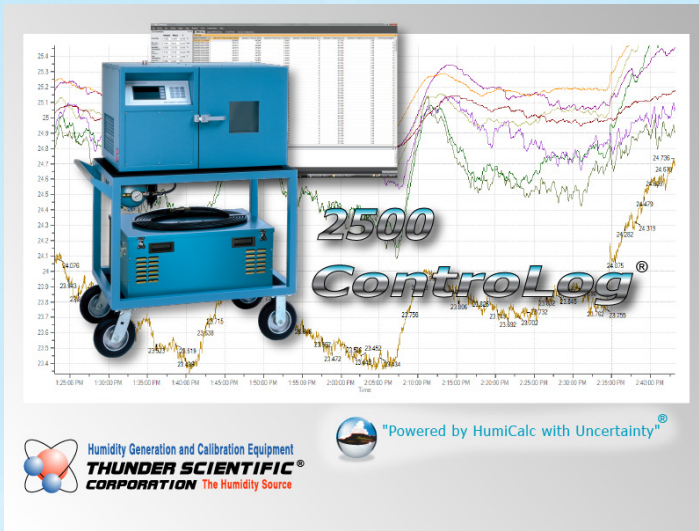

## 3900 ControLog® Automation and Control Software

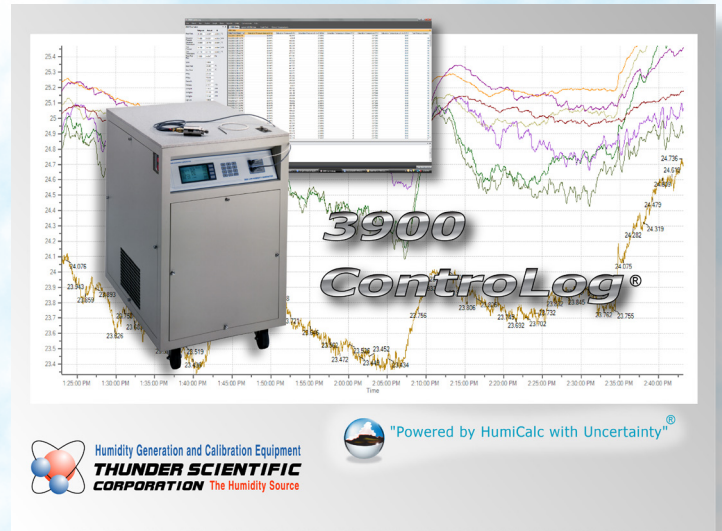

## HumiCalc® with Uncertainty Humidity Conversion Software

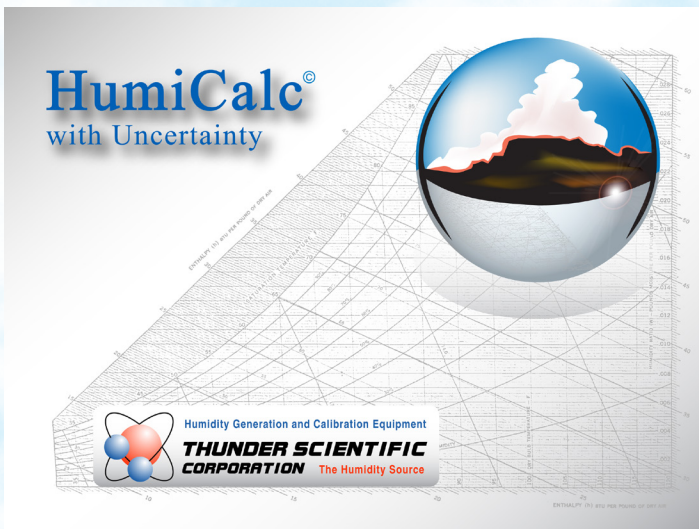



**THUNDER SCIENTIFIC  
CORPORATION**

# 2500 ControLog Software

## FEATURES

- Powerful Graphing Capability Creates a Visual Picture of the Data
- Auto Profiling Feature Automates Humidity Generation
- Data Stored in a Familiar Spreadsheet Type Layout
- Customizable ASCII Interface Support for RS-232, GPIB and Analog Devices
- Uncertainty Calculated in Real-Time by HumiCalc with Uncertainty

## Automation Software for the Model 2500 Humidity Generator

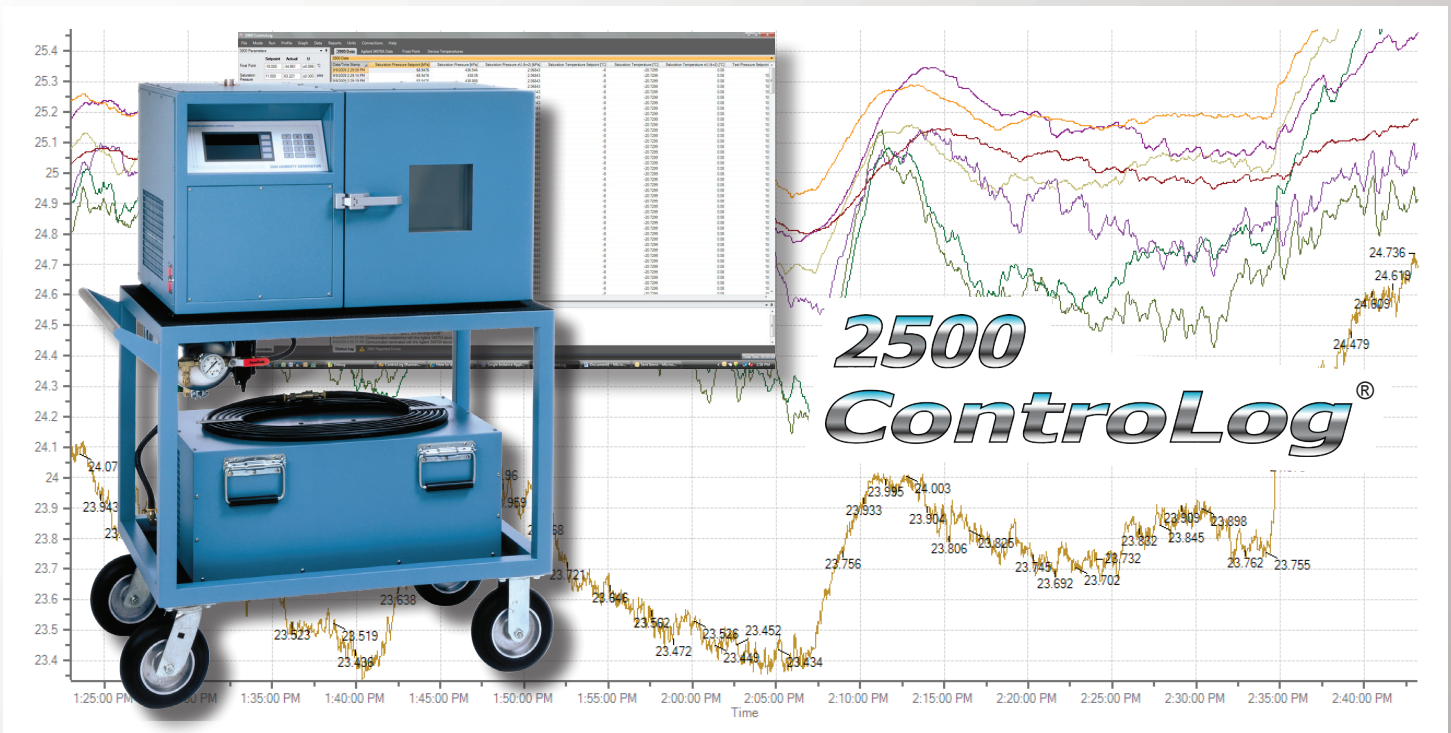

“Power by HumiCalc with Uncertainty”<sup>®</sup>

Download for **FREE**

623 Wyoming Blvd. SE Albuquerque, NM 87123-3198  
Copyright © 2010 - 2023, All Rights Reserved

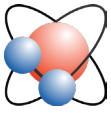

**THUNDER SCIENTIFIC  
CORPORATION**

# 3900 ControLog Software

## FEATURES

- Powerful Graphing Capability Creates a Visual Picture of the Data
- Auto Profiling Feature Automates Humidity Generation
- Data Stored in a Familiar Spreadsheet Type Layout
- Customizable ASCII Interface Support for RS-232, GPIB and Analog Devices
- Uncertainty Calculated in Real-Time by HumiCalc with Uncertainty

## Automation Software for the Model 3900 Low Humidity Generator

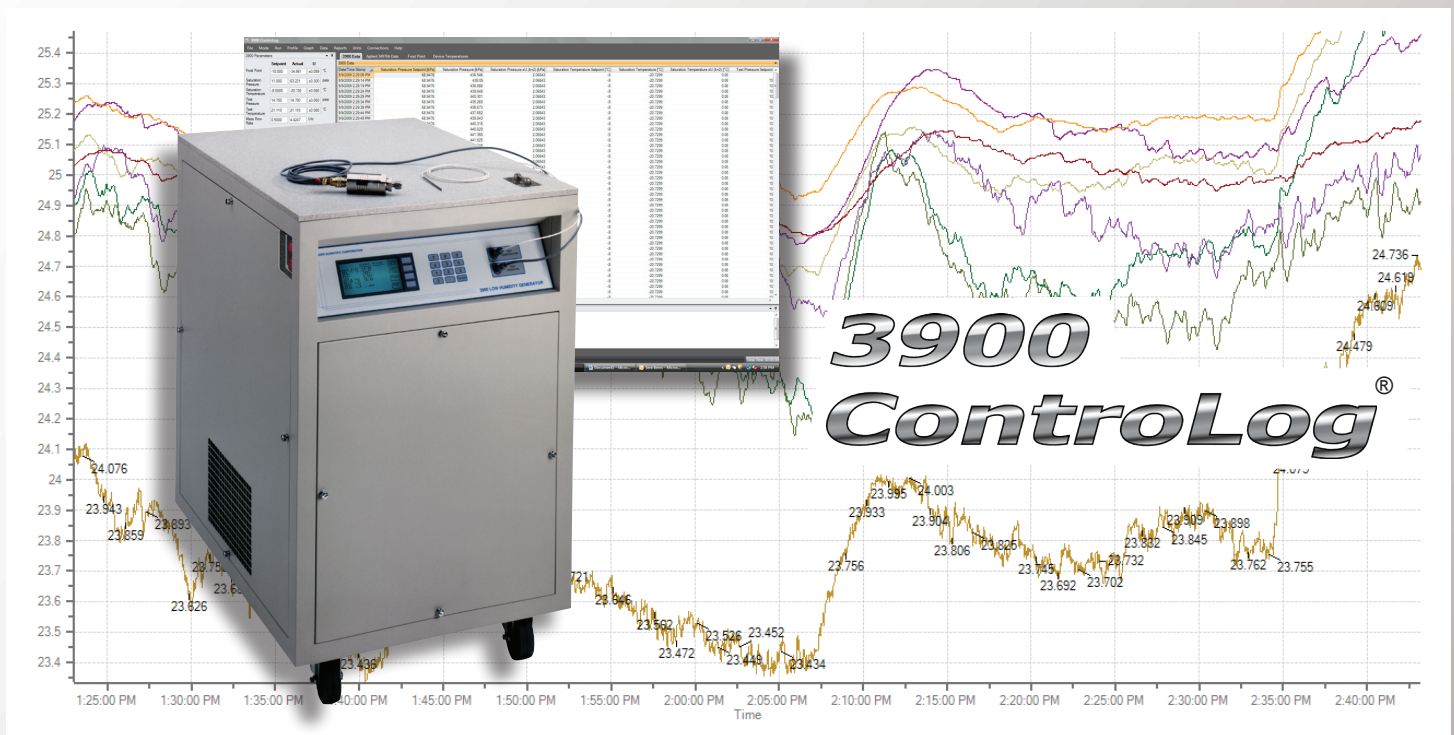

**"Power by HumiCalc with Uncertainty"**®

Download for **FREE**

623 Wyoming Blvd. SE Albuquerque, NM 87123-3198  
Copyright © 2009 - 2023, All Rights Reserved

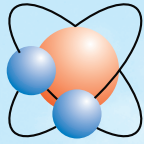

# THUNDER SCIENTIFIC®

## CORPORATION

The Humidity Source

# HumiCalc®

## with Uncertainty

Humidity Calibration and Measurement Instruments

The Ultimate in Complex Humidity Conversions now includes the ability to Calculate Uncertainty. Made for Windows 11, 10, 8.1 and 7.\*\*

### NEW FEATURES

Each known item now contains an uncertainty field that you can expand to enter individual uncertainty components.

Once the calculation is performed, the newly calculated values are displayed along with the expanded uncertainty values at the desired confidence level. Each calculated result can also be expanded to see the individual components that made up the final expanded uncertainty value.

### SPECIFICATIONS

#### HumiCalc® with Uncertainty Minimum System Requirements

- 1GHz Intel® Pentium® or equivalent processor
- 256MB of RAM (512MB recommended for complex uncertainty scenarios)
- Minimum 800 x 600 screen resolution
- Microsoft® Windows® 11, 10 (x86 or x64), Microsoft Windows 8.1 (x86 or x64), Microsoft® Windows 7 (x86 or x64)
- Microsoft .NET Framework version 4.0
- Adobe® Acrobat® Reader
- Internet browser

[Download for FREE](#)

### VALIDATION PACKAGE

HumiCalc® with Uncertainty Validation is a series of documents used to confirm that the HumiCalc® with Uncertainty application complies with its requirements and specifications.

The validation contains around 1,800 pages of test cases composed of detailed mathematical calculations for the core conversion, derivative uncertainty and unit calculations.

This Validation Document can be purchased separately.

### ORDERING INFORMATION

VISA® & MasterCard® and other major credit cards accepted.



\*\* ® Windows 11, 10, 8.1 and 7 are Trademarks of Microsoft Inc.

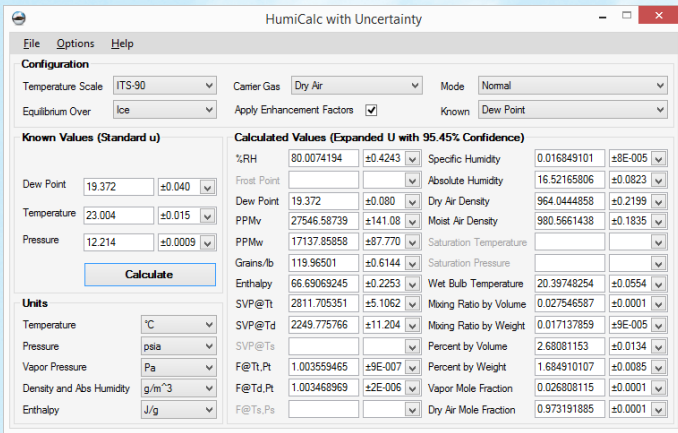

### FEATURES

- Highly Accurate Formulas that Replace Charts and Tables
- Automatically Applies Enhancement Factors and Temperature/Pressure Corrections
- User Selectable Units of Temperature, Pressure, Vapor Pressure, Density, and Enthalpy
- Now includes the ability to Calculate Uncertainty and As Found Error

### DESCRIPTION

HumiCalc® software is the first of its kind to make simple work of complex humidity conversions. No more charts! No more tables! No more guess work! With its high accuracy formulas, HumiCalc® gives you the right answer every time. The new HumiCalc® with Uncertainty expands on the original HumiCalc® with the ability to calculate complex humidity uncertainties with ease.

### UNCERTAINTY FUNCTIONALITY

HumiCalc® with Uncertainty can make simple work of Uncertainty budgets by giving you a calculator that performs all your humidity uncertainty calculations automatically.

## THUNDER SCIENTIFIC®

623 Wyoming Blvd. SE • Albuquerque, New Mexico 87123-3198  
Ordering: 800.872.7728 • Tel: 505.265.8701 • FAX: 505.266.6203

[www.thunderscientific.com](http://www.thunderscientific.com)